

htc®



User Guide

Contents

Getting started

VIVE Flow features	5
What's inside the box?	6
About VIVE Flow	6
Connecting to a power source	8
Putting on VIVE Flow	9
Adjusting the diopter dial	9
About the phone controller	11
About the VR controller	13
Setting up VIVE Flow using the VIVE app or VIVE Flow app	14
Setting up VIVE Flow using the VR controller	16
Signing in with your HTC account	16
Downloading free titles on VIVE Flow	17
Getting titles from VIVEPORT VR	17

Getting the most out of your VR glasses

Connecting to a Wi-Fi network	19
Changing boundary size	20
Turning on Eye comfort mode	20
Changing preferred way to hold phone or VR controller	20
Hand tracking	21
Turning on Passenger mode	22
Mirroring your phone on VIVE Flow	23
Taking screenshots and screen recordings	25
Copying screenshots and screen recordings to your computer	25
Copying files from your computer to VIVE Flow	26
Browsing files on a USB drive	26
Playing videos from local storage	28
Casting your screen	29
Seeing real surroundings (Passthrough)	29
Pairing VIVE Flow with another phone	29
Switching between paired phones or VR controller	30
Setting up hololide on VIVE Flow	31
Switching to hololide mode	31
Pairing Bluetooth devices	31
Setting up and using Kiosk mode	32
Uninstalling apps	32
Installing system and firmware updates	33
About cleaning and disinfecting VIVE Flow	33

VIVE app and VIVE Flow app

What is the VIVE app and VIVE Flow app?	35
What phones do the VIVE app and VIVE Flow app support, and how do I get it?	35
What languages do the VIVE app and VIVE Flow app support?	36
Managing phone notifications	36
Installing system and firmware updates from the VIVE app or VIVE Flow app	36
Uninstalling the VIVE app or VIVE Flow app	36

Common solutions

General	37
System	40
Hardware	44
Apps and content	47

Trademarks and copyrights

Index

About this guide

We use the following symbols to indicate useful and important information:



This is a note. It provides detailed information for setup, common questions, and what to do in specific situations.



This is a tip. It will give you an alternative way to do a particular step or procedure that you may find helpful.



This indicates important information that you need in order to accomplish a certain task or to get a feature to work properly.



This is a warning. Take note to avoid potential problems or prevent damage to your hardware.

Information contained in this guide may have changed. For the most up-to-date information, including the latest version of this guide, go to [VIVE Support](#).

Before using the product, carefully review VIVE safety information and follow all product safety and operating instructions on <https://www.vive.com/legal/>.

Getting started

VIVE Flow features

Lightweight and comfortable

The easy-to-wear VR glasses made for wellness and mindful productivity. Compact and lightweight, VIVE Flow goes where you go. Check out how to put on VIVE Flow in [Putting on VIVE Flow](#) on page 9.

Use your phone or VR controller

Use your phone or VR controller to interact in VR. Connect your Android™ phone to VIVE Flow to get phone notifications while in VR.

- Check out [Setting up VIVE Flow using the VIVE app or VIVE Flow app](#) on page 14 to learn how to set up VIVE Flow using the VIVE app on an Android phone or VIVE Flow app on an iPhone.
- Go to [Setting up VIVE Flow using the VR controller](#) on page 16 to learn how to set up VIVE Flow using the VR controller.

Clear and warm view

VIVE Flow comes with adjustable diopter lenses so you can get a sharp and clear view. Using VIVE Flow close to bedtime is also not a problem with Eye comfort mode.

- Go to [Adjusting the diopter dial](#) on page 9 to learn how to adjust the dials.
- Learn how to turn on eye comfort mode by going to [Turning on Eye comfort mode](#) on page 20.

Phone mirroring

Mirror your Android phone on VIVE Flow to enjoy phone apps on your own personal large screen.

- Learn how to mirror your Android phone in VR by going to [Mirroring your phone on VIVE Flow](#) on page 23.
- Check the list of recommended Android phones for phone mirroring on <https://www.vive.com/vive-flow-phone-list/>.

VIVE app and VIVE Flow app

Use the app to set up, configure Wi-Fi and language, perform system updates, and more for your VIVE Flow.

Learn more about the VIVE app and VIVE Flow app in [What is the VIVE app and VIVE Flow app?](#) on page 35.

What's inside the box?

Your VIVE Flow comes with the following items, which you'll use to experience immersive VR environments:

- VIVE Flow VR glasses
- Face cushion (attached)
- Nose rest (used only when adjusting the diopter dial)
- USB Type-C® cable
- Microfiber pouch

About VIVE Flow

VIVE Flow is your window to the VR environment. The VIVE Flow cameras track the position of the VR glasses.

Front view

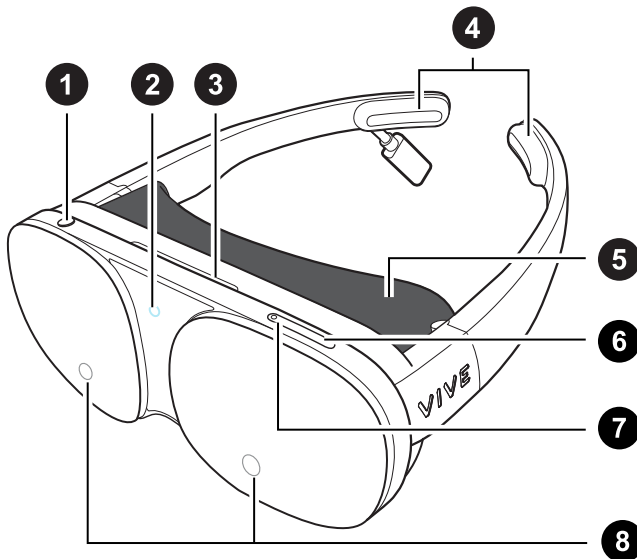

1. Headset button
2. LED (Status light)
3. Vent (Don't block or insert objects into it)
4. Temple pads (Removable)
5. Face cushion
6. Volume down button

7. Volume up button

8. Device cameras

Inside view

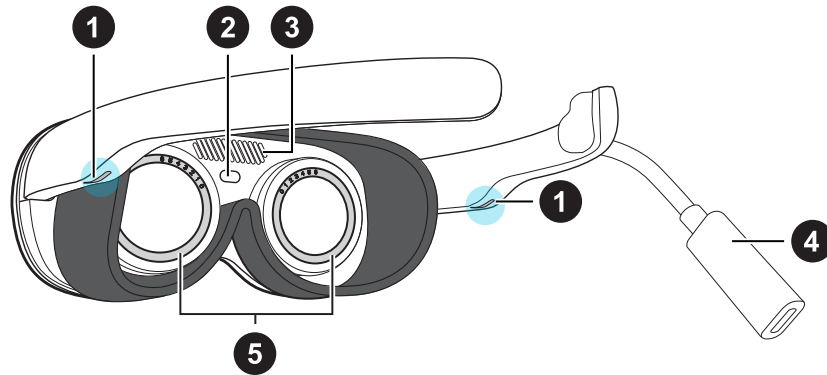

1. Speakers

2. Proximity sensor

3. Vent (Don't block or insert objects into it)

4. USB Type-C receptacle cable

5. Diopter dials

Connecting to a power source

VIVE Flow automatically turns on when plugged in to any power source such as a power bank.



Not all power banks or phones can provide enough power to VIVE Flow. VIVE Flow requires a power source that delivers at least 7.5W of power. If you see an "Insufficient power supply" message in VIVE Flow, connect the VR glasses to another power bank or to a power outlet using an AC adapter. There's no need to press the Headset or Volume buttons after connecting to a new power source.

1. Grab the USB Type-C cable from the box and connect one end to the USB Type-C receptacle cable on VIVE Flow.
2. Connect the other end of the cable to a power source such as a power bank, power outlet, or your phone.

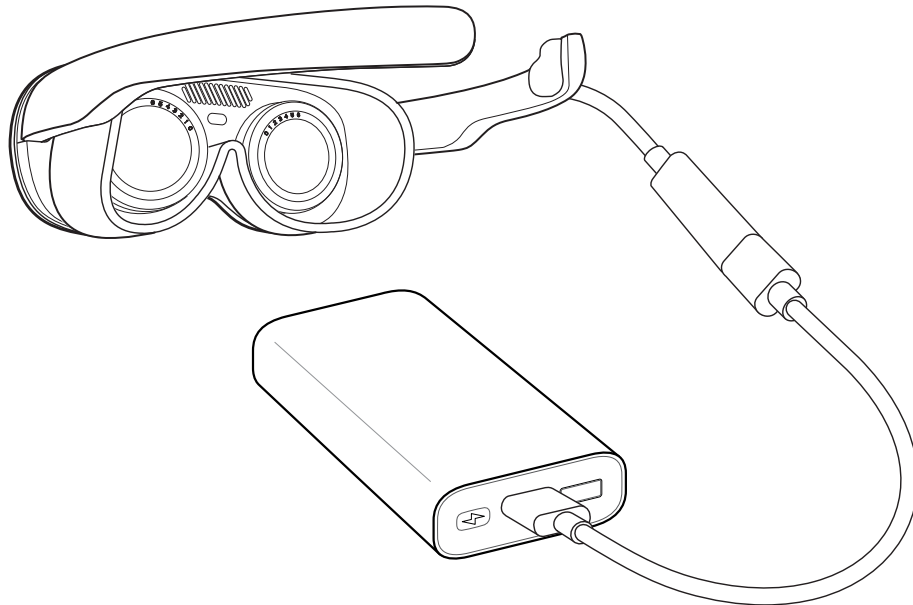

If connecting to a power bank, make sure to connect the USB Type-C cable to the output port of the power bank.

The LED indicator in front will light up when VIVE Flow turns on. After a few seconds, the LED indicator will turn off.



To turn off VIVE Flow, unplug it from the power source.

Putting on VIVE Flow

Open the frame of VIVE Flow, and then wear it as you would regular glasses.



- Before wearing VIVE Flow, connect it to a power source. See [Connecting to a power source](#) on page 8.
- If you wear glasses, remove them first before putting on VIVE Flow.
- It is strongly recommended to take regular breaks. Stop using VIVE Flow if you feel any discomfort.

If VIVE Flow keeps slipping down your nose while using it, adjust the fit of the face cushion. Remove the face cushion, and then squeeze the middle part of the face cushion, below the 2 plastic tabs, for a tighter fit.

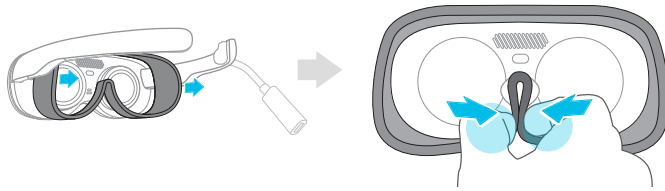

Do not squeeze the 2 plastic tabs as it may damage the face cushion.

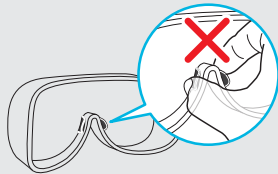

Adjusting the diopter dial

You can adjust the diopter dial even after setting up VIVE Flow. This is useful when sharing your VR glasses with friends or family so they can adjust it to get a clear and sharp view.

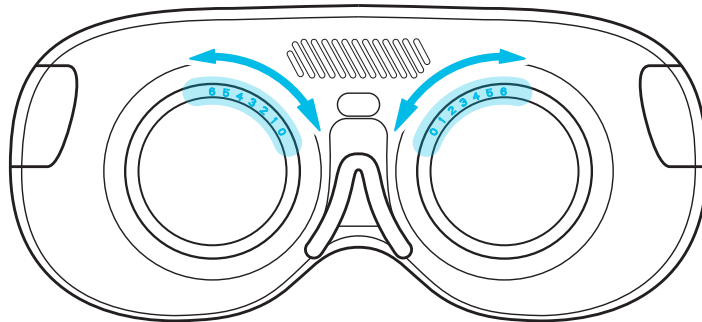

1. If you're currently running an app, tap/press the **VIVE** button on the controller, and then select **Back to Home**.

2. Select **Library > Tutorial > Diopter adjustment.**
3. Follow the onscreen instructions to adjust the diopter dial to get a clear view.



Do not attach the face cushion when adjusting the diopter dial. You only need to attach the nose rest.

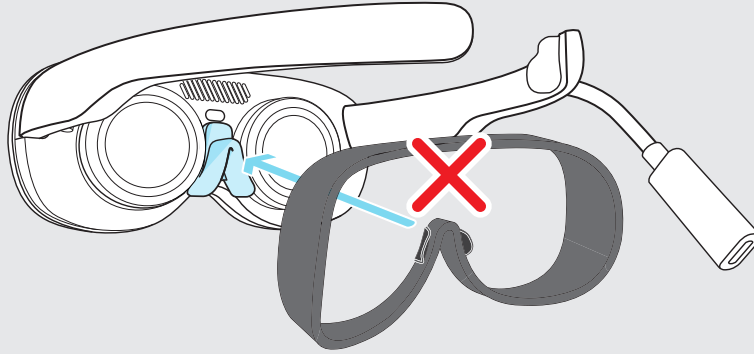

When you've finished the steps, you'll be taken back to Home.



Remember to remove the nose rest and re-attach the face cushion when you're done.

About the phone controller

Use your Android phone or iPhone to interact in VR.



- You need to use the phone that you paired with your VIVE Flow, and make sure your phone and VIVE Flow are connected via Bluetooth®.
- Make sure the phone screen is unlocked.
- You can also use the VR controller or hand gestures to interact in VR. See [About the VR controller](#) on page 13 or [Hand tracking](#) on page 21 for details.

Phone controller interface



- 1. VIVE** Opens the VIVE menu where you can access shortcuts.
- 2. Trigger** Depending on the app, this can either be used as a trigger or to select/drag items. Tap to select items or tap and hold, and then move the phone to drag items.
- 3. Menu** Opens the app menu.
- 4. Select** Depending on the app, tap to select items or tap and hold, and then move the phone to drag items.



- In VR, look down on your hand holding the phone to see the controller layout. You can also see visual feedback when you tap the phone screen.
- To close the currently running app and go back to Home, open the VIVE menu, aim the beam on the Home image, and then select **Back to Home**.

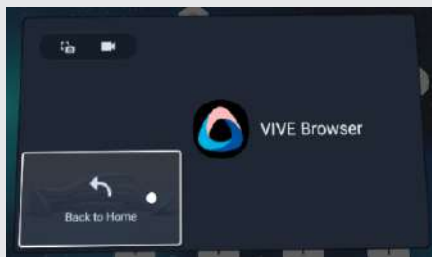

Touch gestures

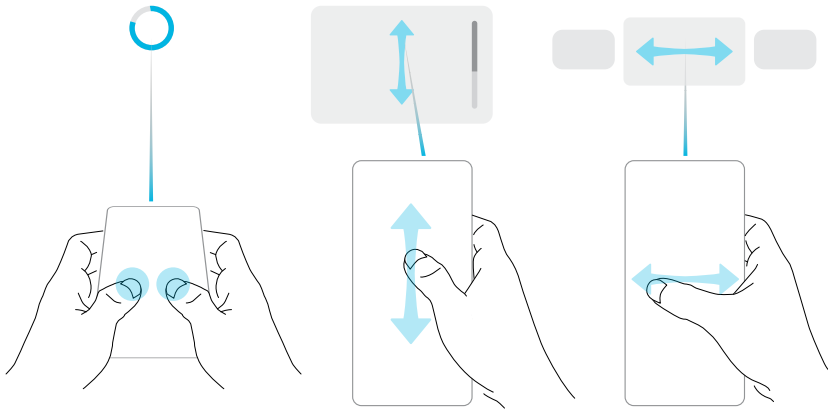

- Aim your phone forward and hold it parallel to the floor, and then tap and hold the screen with two fingers for two seconds to recenter the beam. Do this if the beam orientation is off or you can't see the beam in VR.
- Swipe vertically or horizontally to go through screens.

Disable the phone controller

The phone controller is automatically disabled when you take off VIVE Flow. If you need to use your phone while using VIVE Flow, disable the phone controller. To disable the phone controller:

- On an Android phone, swipe down from the top of the phone screen.

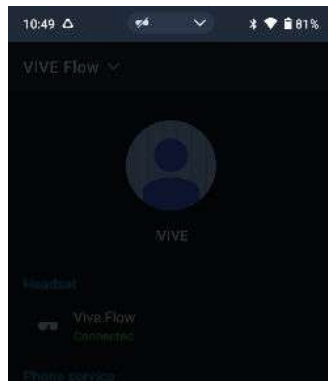

The phone screen is dimmed when the phone controller is enabled.

- On an iPhone, swipe up from the bottom of the screen.

Enable the phone controller

To enable the controller again:

- On an Android phone, swipe down to open the Notifications panel, and then tap **Phone controller disabled: Tap here to enable**.

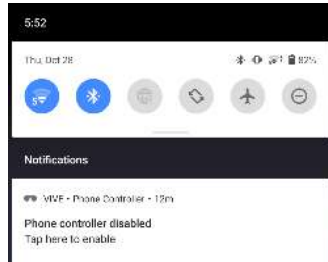

- On an iPhone, do one of the following:
 - If the VIVE Flow app is the active app, just put on VIVE Flow.
 - If the VIVE Flow app is not the active app, tap it in the App Switcher.

About the VR controller

Use the VR controller to interact with objects in VR.



If you don't have the VR controller, you can use your phone as a controller. See [About the phone controller](#) on page 11 for details.

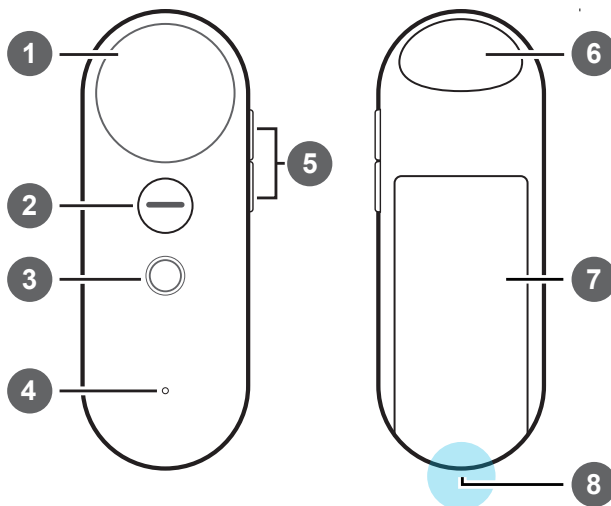

1	Trackpad
2	App button
3	VIVE button
4	Status light
5	Volume control
6	Trigger

7	Battery compartment
8	Lanyard hole



For more information on how to use the VR controller, check the Quick Start Guide in the VR controller box.

Setting up VIVE Flow using the VIVE app or VIVE Flow app

Set up VIVE Flow using your phone with the VIVE app or VIVE Flow app. You'll start setting up VIVE Flow on your phone and then finish setting up on the VR glasses.

1. On your phone, download and install the VIVE app or VIVE Flow app.
 - On an Android phone, get it from <https://www.vive.com/setup/flow> or search **VIVE** on the Google Play Store.
 - On an iPhone, search **VIVE Flow** on the App Store.



If you're using an iPhone, make sure the VIVE Flow software supports connecting to an iPhone. See [Why can't VIVE Flow connect to my iPhone?](#) on page 47.

2. Depending on your phone, open the VIVE app or VIVE Flow app.
3. In the Welcome screen, tap **VIVE Flow**.



If you're using an iPhone, skip to step 4.

4. Tap **Start**. The app will walk you through in setting up the following:

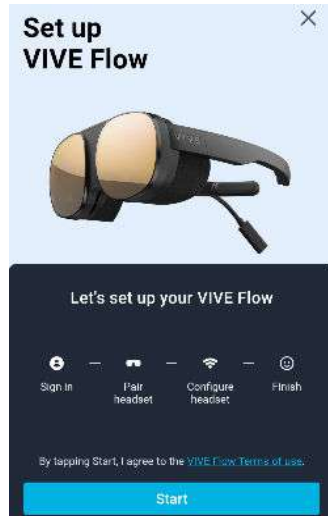

5. Follow the instructions on your phone and VR glasses to set up VIVE Flow. Some things to take note while setting up:
- Keep both VIVE Flow and your phone nearby.
 - When the phone is trying to pair with VIVE Flow, it may take around 20 seconds or more for the phone to find VIVE Flow. Please be patient.
 - While pairing VIVE Flow with the phone, if the device name on VIVE Flow is different from the one on the phone, tap **Show more**. Look for your VIVE Flow in the list.
 - The VIVE app needs phone permissions for you to enjoy the full features of the VR glasses. In the step where you're asked to grant permissions, after tapping **Grant** in each box, you'll be guided on what to turn on. After granting permission, tap the back arrow until you get back to the VIVE app.



Granting permissions is only for Android phones.

- When using a phone controller, VIVE Flow can only connect to a Wi-Fi® network that supports Wi-Fi 802.11 a/ac/n (5 GHz band). Make sure your Wi-Fi router or phone's Wi-Fi hotspot is set to the 5 GHz band. To learn how to set your phone's Wi-Fi hotspot to 5 GHz, see [Why can't VIVE Flow find my phone as a Wi-Fi hotspot?](#) on page 37. To learn how to set your Wi-Fi router to the 5 GHz band, consult its user guide.
- When going through the setup process on VIVE Flow, take note of the position of the Headset button as you'll need to press it to go to the next step. See [About VIVE Flow](#) on page 6.



If you have trouble pairing VIVE Flow with your phone, make sure VIVE Flow is connected to a power source and near your phone.

Setting up VIVE Flow using the VR controller

You can use the VR controller to set up VIVE Flow.



If you don't have the VR controller, check the VIVE accessories website in your region and see if the VR controller is available.

Make sure you've inserted the batteries into the VR controller before setting up VIVE Flow.

1. Connect VIVE Flow to a power source. See [Connecting to a power source](#) on page 8.
2. Put on VIVE Flow, and then press and hold the Headset button until the progress bar is full. See [About VIVE Flow](#) on page 6 to see the location of the Headset button.
3. Move your head and point the beam toward the language you want to use.
4. Go through the hardware tutorial. When you reach the **Select setup method** step, select **General setup**.
5. Follow the instructions on VIVE Flow. Make sure you can easily reach for the VR controller as you need to use it while setting up VIVE Flow.

Signing in with your HTC account

Sign in for the best experience and support. The best way to sign in is with the VIVE app, but you can also sign in while in VR.



If you don't have an HTC account, we recommend creating one first on your computer. On your web browser, go to <http://www.viveport.com/>, and then click **Sign In** at the top-right corner.

1. From Home, select **Profile**.
2. Type your user name and password, and then select **Sign in**.

Downloading free titles on VIVE Flow

There may be some free titles available for download on your VIVE Flow.

1. To check if there are free titles, select **Library** from Home.
2. Select  > **Not Installed**.



3. Select a free title to download and install it.
4. To switch back to the installed titles in the VR Library, select  > **Installed**.

Getting titles from VIVEPORT VR

VIVEPORT™ VR offers a convenient way for users to access new titles and other content. Before purchasing, you can browse through titles in VIVEPORT VR from your VR glasses.

Access VIVEPORT VR by selecting **Store** from Home.

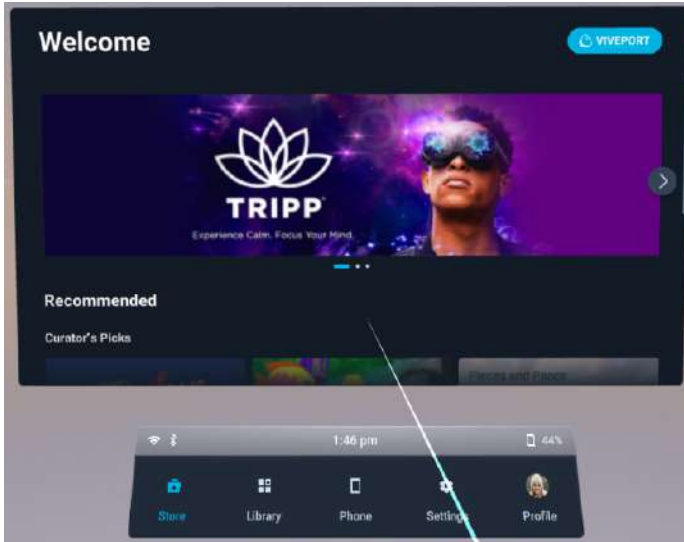

Getting the most out of your VR glasses

Connecting to a Wi-Fi network

It's easy to connect to Wi-Fi using the VIVE app or during the setup process, but you can also add or change networks from Settings.



When using a phone controller with VIVE Flow, VIVE Flow can only connect to a Wi-Fi network that supports Wi-Fi 802.11 a/ac/n (5 GHz band). Make sure your Wi-Fi router or phone's Wi-Fi hotspot is set to the 5 GHz band. To learn how to set your phone's Wi-Fi hotspot to 5 GHz, see [Why can't VIVE Flow find my phone as a Wi-Fi hotspot?](#) on page 37. To learn how to set your Wi-Fi router to the 5 GHz band, consult its user guide.

1. If you're currently running an app, tap/press the **VIVE** button on the controller, and then select **Back to Home**.
2. From Home, select **Settings**.
3. In **Connectivity**, select **Wi-Fi**.
4. Choose a Wi-Fi network to add from the list. If your network is hidden, add it manually by selecting **Add Network** at the bottom of the list.
5. If this is the first time you've connected to this network, enter your network information.



- For some public Wi-Fi networks, such as the ones in hotels or airports, you'll need to open a web browser to log in to connect to the Wi-Fi network. In VR, open VIVE Browser, and then go to any website. VIVE Browser will redirect you to the log in page where you can enter the required credentials to connect.
- You can also use the VIVE app or VIVE Flow app to set up Wi-Fi for VIVE Flow. In the app, tap your VIVE Flow under Headset, and then tap **Headset Wi-Fi**.

Changing boundary size

The boundary system automatically activates when you're close to the edge of your play area to help keep you safe. If you have a lot more open space for your play area, you can change the boundary size.

1. If you're currently running an app, tap/press the **VIVE** button on the controller, and then select **Back to Home**.
2. From Home, select **Settings**.
3. In **Boundary**, select the size you want in Boundary size.

Turning on Eye comfort mode

Reduce digital eye strain by turning on Eye comfort mode while using VIVE Flow. When using VIVE Flow at night, turning on Eye comfort mode may also help you sleep better.

1. If you're currently running an app, tap/press the **VIVE** button on the controller, and then select **Back to Home**.
2. From Home, select **Settings**.
3. Select **General**, and then select the Eye comfort mode **On/Off** switch to turn it on.
4. Drag the **Intensity** slider to the level you want.

Changing preferred way to hold phone or VR controller

Changing the preferred way to hold your phone controller or VR controller changes the angle of the beam emitted from the controller.

1. If you're currently running an app, tap/press the **VIVE** button on the controller, and then select **Back to Home**.
2. From Home, select **Settings**.
3. In **Controller**, choose how you want to hold your phone or VR controller.

Hand tracking

The hand tracking feature, currently in beta, allows you to use your hands as controllers with VIVE Flow.



The hand tracking feature is included in the VIVE Wave SDK. Developers can add hand tracking support to VR apps to provide a more immersive VR experience.

1. Go to **Settings > Input** and turn on **Hand tracking (BETA)**.
2. Place the controller on a level surface and position your hands in front of the headset. A 3D likeness of your hands and a corresponding cursor will appear in front of you.

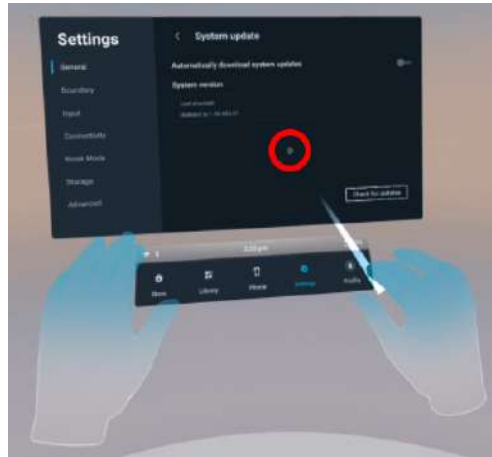

3. You can use the following hand gestures:

- **Pinch to select**

With your palm facing outward, move your hand to position the cursor, and then pinch your thumb and index finger together to select.

- **Pinch and drag to scroll**

With your palm facing outward, pinch and drag to scroll pages or move sliders.



- **Pinch inward to open the VIVE Menu**

With your right palm facing inward, pinch your fingers together to open the VIVE Menu. Use the same gesture to close the menu.



When you pinch your fingers together, check that you see the VIVE™ logo.



- To resume use of the phone or VR controller, simply pick it back up.
- To switch the beam to your other hand, pinch the thumb and index finger together on the hand you want to use.

Turning on Passenger mode

When using VIVE Flow in a moving vehicle or dark environment, turn on Passenger mode to prevent drifting.

1. If you're currently running an app, tap/press the **VIVE** button on the controller, and then select **Back to Home**.
2. From Home, select **Settings**.
3. In **General**, tap the Passenger mode **On/Off** switch to turn it on.

You can also turn on or off Passenger mode by opening the VIVE app or VIVE Flow app, tapping your VIVE Flow under Headset, and then tapping the Passenger mode **On/Off** switch.

Mirroring your phone on VIVE Flow

You can mirror what's on the phone screen inside VIVE Flow. Enjoy apps and watch your favorite shows on a personal large screen in VR.



- Phone mirroring is only available when using Android phones.
- Your phone needs to support Miracast™ in order to mirror your phone screen on VIVE Flow.
- Make sure your phone is unlocked and the screen is on.

1. From Home, select **Phone** > **Let's go**.



Your phone screen will then appear in VR.



If you're using the VR controller and you haven't paired VIVE Flow with your phone before, you'll see **Pair phone** instead of **Let's go**. Select **Pair phone**, and then follow the steps in [Setting up VIVE Flow using the VIVE app or VIVE Flow app](#) on page 14. When you get to the step where you need to enter the pairing code, enter the pairing code you see on VIVE Flow.





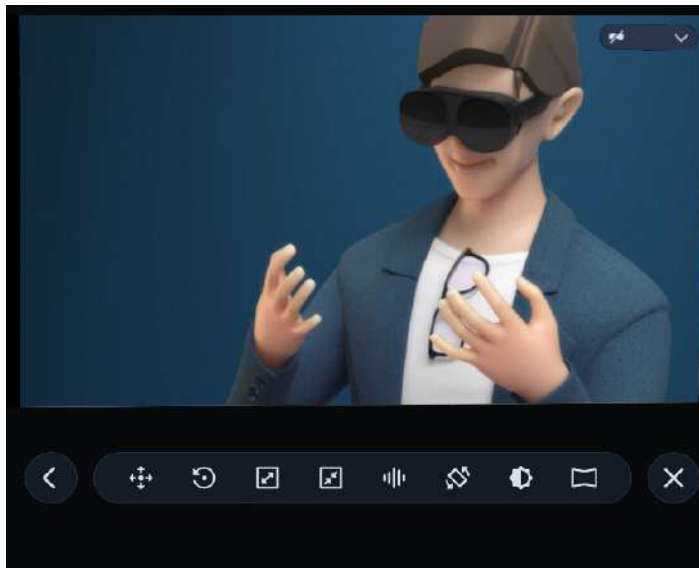





2. You can:

- Aim the beam on the phone screen to interact with your phone such as selecting an app to open it.
- Play back videos and watch them on your own personal large screen in VR.



- Use the toolbar to manage the phone mirroring experience.





	Go back to the previous screen.
	Reposition the phone screen in VR. Move the screen to its new position first before selecting Done . If you're lying down on your side, turn on Sync with headset rotation first before moving the screen.
	Reset phone screen position and zoom level back to default settings.
	Zoom in on the phone screen.
	Zoom out of the phone screen.
	Open your phone's voice assistant (for example, Google Assistant™).
	Switch the phone screen orientation to portrait or landscape.
	Make the background lighter or darker.
	While watching videos in full screen, switch between a flat or curved screen.
	Exit phone mirroring.



- If you don't see the toolbar, tap your phone screen or move your phone from side to side. If you're using a VR controller, move the controller from side to side.
- Aim the beam at a button on the toolbar to see what it does.
- When you're using an app in full screen and in landscape orientation, select  on the toolbar to exit full screen mode.
- Make sure the volume of your phone is not muted.

Taking screenshots and screen recordings

Screenshots and video recordings save VR moments for review or sharing. To take screenshots or video recordings:

1. On the controller, tap/press the **VIVE** button.
2. Do either of the following:
 - Select  to take a still screenshot.
 - Select  to record video from your VR screen and audio from your microphone.

VIVE Flow will quickly count down from 3, and then start your capture.

3. For screen recordings, you can stop the capture process by selecting **Stop recording**. If you've chosen video capture, your video capture will continue until you stop it or your VIVE Flow runs out of storage space.

Captures are stored on VIVE Flow.



- Take a quick screenshot by pressing the Headset and Volume down buttons.
- Take quick screen recordings by pressing the Headset and Volume up buttons. Press the same buttons again to stop recording.
- Screenshots and screen recordings may be disabled in some apps.

Copying screenshots and screen recordings to your computer

Copy your captured screenshots and screen recordings from VIVE Flow to your computer.

Here's how to copy files from VIVE Flow to a Windows® computer:

1. Connect one end of the USB Type-C cable to the USB receptacle cable on VIVE Flow and the other end to your computer.
2. Put on your VIVE Flow.
3. In the Choose USB mode dialog box, select **File transfer**.
4. Take off your VIVE Flow.
5. On your computer, open a file management app such as File Explorer, and then click **VIVE Flow**.
6. Click **Internal shared storage**. You'll find screenshots in **Pictures > Screenshots** and screen recordings in the **Movies** folder.

7. Open the folder you want to copy files from. Select the files, and then copy them to a folder in your computer.
8. When done, disconnect VIVE Flow from the computer.

To copy files from the VR glasses to a Mac computer, use a file transfer tool such as Android File Transfer. Go to android.com/filetransfer/ to download and learn how to use Android File Transfer.

Copying files from your computer to VIVE Flow

Copy files such as photos and videos from your computer to VIVE Flow.

Here's how to copy files from a Windows computer to VIVE Flow.

1. Connect one end of the USB Type-C cable to a USB port on your computer and the other end to VIVE Flow.
2. Put on your VIVE Flow.
3. In the Choose USB mode dialog box, select **File transfer**.
4. Take off your VIVE Flow.
5. On your computer, open a file management app such as File Explorer, and then open the folder you want to copy files from.
6. Select the files, and then copy them to a folder in **Internal shared storage** on VIVE Flow, which you can find in File Explorer.
7. When you're done, disconnect VIVE Flow from the computer.

To copy files from a Mac computer to VIVE Flow, use a file transfer tool such as Android File Transfer. Go to android.com/filetransfer/ to download and learn how to use Android File Transfer.

Browsing files on a USB drive

View photos and videos and install app APK files from a USB drive.



- You need a USB Type-C dongle and power source such as a power bank.
- The USB Type-C dongle needs to have one port that supports power input and another port that supports data transfer.
- The USB drive must be formatted in the **FAT32** format.

Here's how to browse files from a USB drive using VIVE Flow.

1. Copy the files you want to browse on VIVE Flow on the USB drive.
2. Connect your USB drive to the port on the dongle that supports data transfer.
3. Connect the power source to the port on the dongle that supports power input.

4. Connect the USB Type-C cable of the dongle to the USB Type-C receptacle cable on VIVE Flow.

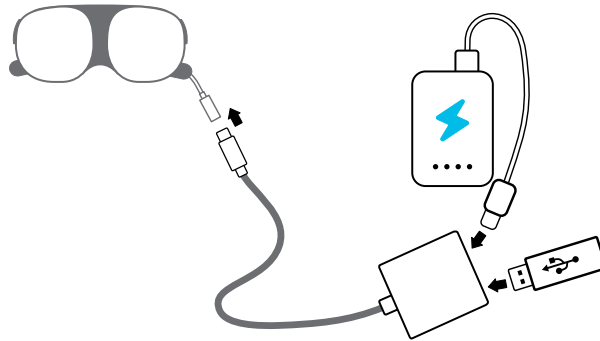

5. Put on VIVE Flow.
6. From Home, select **Settings** > **Storage**.

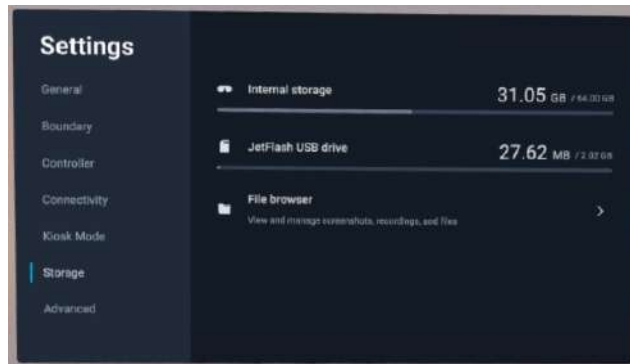

 You'll see your USB drive below **Internal storage**. If you don't see your USB drive, try plugging in the USB drive again to the dongle.

7. Select **File browser**, and then select the folder you want to browse on your USB drive.
8. Do any of the following:
 - Select an image or video file to view it.
 - Select an app APK file to install it on VIVE Flow.

Playing videos from local storage

You can play videos from VIVE Flow local storage through **VIVEPORT Video**, which supports playback of standard (or flat), stereoscopic 3D, and 180- or 360-degree videos. Supported file formats include: **.mp4**, **.mkv**, and **.webm**.

The **VIVEPORT Video** app on VIVE Flow can be used to play videos from local storage. You can add videos to local storage manually by copying them from your computer to VIVE Flow. For details, see [Copying files from your computer to VIVE Flow](#) on page 26.

1. If you're currently running an app, tap/press the **VIVE** button on the controller, and then select **Back to Home**.
2. From Home, go to the **Library** and launch **VIVEPORT Video**.



If you don't see **VIVEPORT Video** in the **Library**, you'll have to download and install it using the **VIVEPORT VR** app.

3. Select the folder that contains the video you want to play.
4. Point to the video you want to play and tap/press Trigger to open it.
5. While the video is playing, you can:
 - Play or pause the video using the playback controls.
 - Toggle the Mini Browser on or off.
 - Adjust the **Visual Settings** (below the playback controls) so you can watch the video in a 180- or 360-degree view, on a curved or flat display, and more.
 - Add subtitles by selecting **Select Audio and Subtitles** (the message icon with 3 dots) below the playback controls and choosing a subtitle file associated with the video.
 - Adjust general **Settings** such as autoplay and video looping.
 - Select **Move & Resize**, and then do either of the following:
 - **Move:** Press and hold Trigger, then drag the screen around to reposition it.
 - **Resize:** Select the plus and minus buttons or drag the slider to adjust the zoom level.

You can also play back regular videos directly in the **File browser**. Copy the videos to the **Downloads** folder on VIVE Flow to access them in the **File browser**. See [Copying files from your computer to VIVE Flow](#) on page 26.

Casting your screen

You can share what you see in VR with an external device wirelessly in real time. Your view in VR will appear on the device you choose, allowing you to share your VR experience, or watch the VR experiences of others.



VIVE Flow supports connecting to Miracast devices on the 5 GHz band.

1. On the controller, tap/press the **VIVE** button.
2. Select **Cast**.
3. Choose a device to cast to. If your device is not on the list, make sure your device is set to receive an incoming cast.



- Screen casting pauses automatically when you access certain kinds of personal information, such as password screens. Screen casting may also be disabled in some apps.
- Screen casting is not supported when in Phone mode. See [Mirroring your phone on VIVE Flow](#) on page 23.

Seeing real surroundings (Passthrough)

With the passthrough feature on VIVE Flow, you can see your real surroundings without taking the VR glasses off.

Press the Headset button twice to see your actual surroundings in black and white. To go back into VR, press the Headset button twice again.

Pairing VIVE Flow with another phone

You can pair VIVE Flow with several phones if it's a shared device.

1. If you're currently running an app, tap/press the **VIVE** button on the controller, and then select **Back to Home**.
2. From Home, select **Settings**.

3. Select **Connectivity > Phone pairing (VIVE app)**.
4. On the phone you want to connect to VIVE Flow, follow the steps in [Setting up VIVE Flow using the VIVE app or VIVE Flow app](#) on page 14.

After the new phone connects to VIVE Flow, you'll see an **Unable to connect** message on the phone that was previously connected to VIVE Flow. Tap **OK** to close the message. You can still reconnect the phone to VIVE Flow next time. To learn how to reconnect, see [Switching between paired phones or VR controller](#) on page 30.



- Only one phone can be connected to VIVE Flow at a time.
- VIVE Flow can only automatically reconnect with the last connected phone.
- If you can't reconnect your phone to VIVE Flow, refer to [Why can't I reconnect my phone with VIVE Flow?](#) on page 41.

Switching between paired phones or VR controller

If your VIVE Flow is paired with several phones or the VR controller, you can switch between them on VIVE Flow.

1. While wearing VIVE Flow, press and hold the Volume up and Volume down buttons until the **Switch controller** window opens.
2. Do any of the following:
 - Select the phone you want to use with VIVE Flow.
 - Make sure your VR controller is nearby, and then select **Switch now** to connect it to VIVE Flow.



- If you don't see the phone you want to switch to, see [Why can't I reconnect my phone with VIVE Flow?](#) on page 41.
- If VIVE Flow is paired with more than one phone, select **Switch to VR controller** to connect the VR controller to VIVE Flow.

3. If you chose to switch to a phone, open the VIVE app on the phone you selected.
4. Under Headset, tap your VIVE Flow.



You can also change the headset's input type to phone controller or VR controller. Go to **Settings > Controller**, and then select the controller input toggle in the upper right.

Setting up holoride on VIVE Flow

holoride™ syncs VR with the physical movements of your vehicle to create immersive in-car experiences.

You'll need a compatible vehicle and gamepad to use holoride.

1. Connect VIVE Flow to a power source. See [Connecting to a power source](#) on page 8.
2. Put on VIVE Flow, and then press and hold the Headset button until the progress bar is full. See [About VIVE Flow](#) on page 6 to see the location of the Headset button.
3. Move your head and point the beam toward the language you want to use.
4. Go through the hardware tutorial. When you reach the **Select setup method** step, select **holoride mode**.
5. Follow the instructions on VIVE Flow. Make sure you can easily reach for the gamepad as you need it to set up holoride on VIVE Flow.

For more details on how to use holoride, go to <https://holoride.com/faq>.

Switching to holoride mode

Here's how to enter holoride mode on VIVE Flow.



Make sure the gamepad paired with VIVE Flow is nearby before entering **holoride mode**. You'll need it to set up and use holoride.

1. While wearing VIVE Flow, press and hold the Headset button until a menu appears.
2. On the menu, select **holoride mode**.
3. If you haven't set up holoride before, you'll be asked to set it up first.

To exit holoride mode, press and hold the Headset button, and then select **Exit holoride mode**.



Make sure the phone or VR controller that's paired with VIVE Flow is nearby before exiting holoride mode. You'll need your phone or VR controller to interact in VR after exiting holoride mode.

Pairing Bluetooth devices

You can pair audio devices such as Bluetooth headphones or speakers with VIVE Flow. Here's how:

1. If you're currently running an app, tap/press the **VIVE** button on the controller, and then select **Back to Home**.
2. From Home, select **Settings**.
3. Select **Connectivity > Bluetooth > Pair new device**.

4. Make sure that Bluetooth is on and that your other device is nearby and in pairing mode.
5. Select your device from the list.
6. If your device uses a PIN or code, type the PIN or verify the code.
7. Select **Pair** to pair your device.

Setting up and using Kiosk mode

Kiosk mode is a custom dashboard that allows you to control what apps a user can access while using VIVE Flow. This is helpful for demonstrations, training, or certain enterprise environments where full control of the headset might not meet organizational needs.

To set up and enter Kiosk mode:

1. If you're currently running an app, tap/press the **VIVE** button on the controller, and then select **Back to Home**.
2. From Home, select **Settings**.
3. Select **Kiosk Mode**.
4. Choose what apps, features, and settings will be available in Kiosk mode.



- For **Assign apps**, if **Single app** is selected, VIVE Flow will automatically launch the app. If **Multiple apps** is selected, VIVE Flow will show a screen where the user can launch the app from the library and change certain settings.
- For **Interaction method**, select **Gaze** to let users select items in apps by simply aiming the beam at them. The app needs to support Gaze mode.

5. Select **Enter Kiosk Mode** to start Kiosk mode.

To leave Kiosk mode, press and hold the headset button until a menu appears, and then select **Quit Kiosk mode**. Enter your passcode if you have one.

Uninstalling apps

Whether you want to free up space or no longer need it, it's easy to uninstall apps.

1. If you're currently running an app, tap/press the **VIVE** button on the controller, and then select **Back to Home**.
2. From Home, select **Settings**.
3. Select **Storage**.
4. Highlight the app on the list by pointing at it, and then select the **Trash** icon.



You can reinstall apps later.

Installing system and firmware updates

Keep your VIVE Flow system and firmware up-to-date with the latest features or enhancements. Your VR glasses will check for updates periodically, or you can check manually. Here's how:

1. If you're currently running an app, tap/press the **VIVE** button on the controller, and then select **Back to Home**.
2. From Home, select **Settings**.
3. Under **General**, select **System update**.
4. Select **Update** to begin the update process.



- It is highly recommended to plug VIVE Flow to a power bank or power outlet using an AC adapter when doing system and firmware updates.
- Some updates may require restarting your VR glasses.
- You can also update the VR glasses through the VIVE app or VIVE Flow app. See [Installing system and firmware updates from the VIVE app or VIVE Flow app](#) on page 36.

About cleaning and disinfecting VIVE Flow

Keep VIVE Flow clean and hygienic with a few simple tips.

Do's

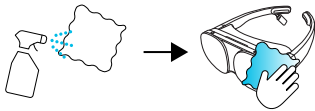

- Dampen a cloth with a neutral and soft cleaner to wipe down the hard plastic of the VR glasses you touch most.
- Using a UVC cleaner is an effective and recommended way to decontaminate VR headsets and controllers. Before using a UVC cleaner on your VR devices, make sure to properly cover the headset lenses. Discoloration due to UV exposure is not covered by warranty.

Don'ts

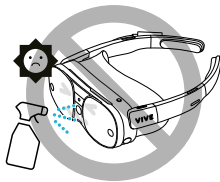

- Don't spray or pour liquid directly on your VR glasses.
- Don't use any liquids or cleaning solutions on the lenses.
- Don't expose your VR glasses to direct sunlight.

- Don't use volatile solvent such as alcohol to wipe the temple pads.
- Don't wash the face cushion and temple pads.
- Don't machine wash.

Cleaning the VR glasses lenses

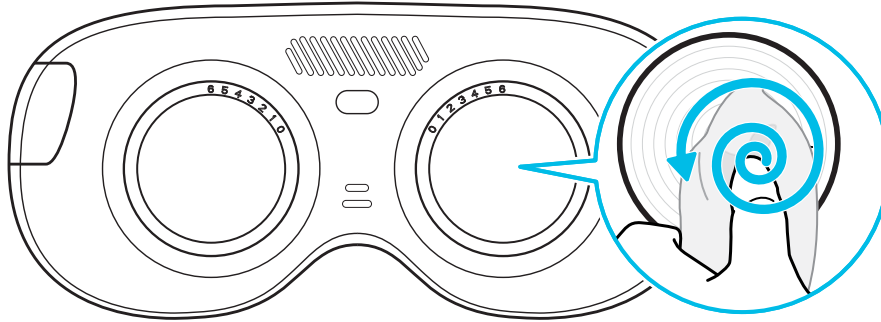

- Use a dry cleaning cloth to wipe the lenses, such as the microfiber pouch.
- Never use any kind of cleaning solution on the lenses.
- Wipe in a circular motion from the center to the outer edges of the lenses.

VIVE app and VIVE Flow app

What is the VIVE app and VIVE Flow app?

These are apps for Android phones and the iPhone that let you set up and manage VIVE Flow. With the app, you can:

- Easily set up your VIVE Flow.
- Manage phone notifications in VR.



Phone notifications are only available when using Android phones.

- Stay up to date with the latest releases.
- Perform a factory reset (hard reset) of VIVE Flow.

What phones do the VIVE app and VIVE Flow app support, and how do I get it?

App name	Install on
VIVE app	<p>Android phones with Android 9.0 or later.</p> <p>You can download the app from:</p> 
VIVE Flow app	<p>iPhone 8 or newer with iOS 14.4.2 or later.</p> <p>You can download the app from:</p> 



- Your phone must be connected to Wi-Fi and have Bluetooth enabled to set up VIVE Flow.
- For a list of recommended Android phones to use with VIVE Flow, go to <https://www.vive.com/vive-flow-phone-list/>.

What languages do the VIVE app and VIVE Flow app support?

The app language is set by your phone settings. If your phone language isn't supported, the app will choose another language from your region. If no language is available, it will default to English.

Managing phone notifications

Don't worry about missing important notifications while in VR. Manage which notifications you get while using VIVE Flow.



Phone notifications are only available when using Android phones.

1. In the VIVE app, tap **Notifications** under Phone service.
2. Choose the notifications you want to receive while in VR, and then tap the back arrow.
3. Tap the Notifications **On/Off** switch to turn it on or off.

Installing system and firmware updates from the VIVE app or VIVE Flow app

Here's how to check for the latest system and firmware updates for your VR glasses and install them:

1. In the app, tap your VIVE Flow under Headset.
2. If you see that there's an available update, tap **System update** > **Update**.

It is highly recommended to plug VIVE Flow to a power bank or power outlet using an AC adapter when doing system and firmware updates.

Uninstalling the VIVE app or VIVE Flow app

It's easy to uninstall the app from your phone.

Do one of the following:

- On an Android phone, go to **Settings** > **Apps**, look for and tap VIVE app, and then tap **Uninstall**.
- On an iPhone, tap and hold the VIVE Flow app, and then tap **Remove App** > **Delete App** > **Delete**.

Common solutions

General

Why can't VIVE Flow find my phone as a Wi-Fi hotspot?

It may be because the Wi-Fi hotspot band of your phone is set to 2.4 GHz. When using a phone controller with VIVE Flow, VIVE Flow can only connect to a Wi-Fi hotspot using the 5 GHz band. Check the table below to see how to change your phone's Wi-Fi hotspot band to 5 GHz.

Phone manufacturer	Wi-Fi hotspot 5 GHz setting path
ASUS™	<ol style="list-style-type: none"> 1. Go to Settings > Network & internet > Hotspot & tethering > Wi-Fi hotspot. 2. Tap AP Band > 5.0 GHz Band or Both.
HTC	<ol style="list-style-type: none"> 1. Go to Settings > Network & internet > Hotspot & tethering > Portable Wi-Fi hotspot or swipe down from the top of the screen to open the Notifications panel, and then tap and hold the Hotspot button. 2. Tap ⋮ > Advanced > Wi-Fi frequency band selection > 5GHz.
Huawei	<ol style="list-style-type: none"> 1. Go to Settings > Mobile network > Personal hotspot > More. 2. Tap AP band > 5 GHz.
iPhone	<ol style="list-style-type: none"> 1. Go to Settings > Cellular > Personal Hotspot or Settings > Personal Hotspot 2. Make sure Maximize Compatibility is off.
LG®	<ol style="list-style-type: none"> 1. Go to Settings > Network & internet > Tethering > Wi-Fi hotspot > Set up Wi-Fi hotspot > Show advanced options. 2. Under Broadcast channel, tap 5GHz.
OnePlus™	<ol style="list-style-type: none"> 1. Go to Settings > Wi-Fi & network > Hotspot & tethering > Wi-Fi hotspot. 2. Tap AP Band > 5.0 GHz Band.
Oppo or Realme	<ol style="list-style-type: none"> 1. Go to Settings > Connection & sharing > Personal hotspot > Personal hotspot settings. 2. Tap AP band > 5 GHz band.
Samsung	<ol style="list-style-type: none"> 1. Go to Settings > Connections > Mobile Hotspot and Tethering > Mobile Hotspot > Configure.

Phone manufacturer	Wi-Fi hotspot 5 GHz setting path
	2. Tap Band > 5 GHz preferred .
Sony™	<ol style="list-style-type: none"> 1. Go to Settings > Network & internet > Hotspot & tethering > Portable hotspot 2. Tap AP Band > 5.0 GHz Band preferred.
Vivo	<ol style="list-style-type: none"> 1. Go to Settings > Other networks and connections > Personal Hotspot > Hotspot configuration. 2. Tap AP band > 5 GHz band.
Xiaomi	<ol style="list-style-type: none"> 1. Go to Settings > Connection & sharing > Portable hotspot > Set up portable hotspot. 2. Tap Select AP Band > 5.0 GHz Band.

How can I optimize tracking in my space?

VIVE Flow uses inside-out tracking, relying on the unique appearance of your surroundings to orient the VR glasses and maintain your position in VR. Here are some tips to improve tracking in your space:

- Avoid direct intense light or glare, both on the VR glasses and in your space.
- Your space should be bright enough to read a book comfortably.
- Minimize reflective objects.
- Patterns on the walls, ceiling, and floor can help improve tracking. Try to minimize completely blank surfaces.
- Keep your play area clear of obstacles.

What do I do if VIVE Flow suddenly loses power when using the phone controller as a power source?

VIVE Flow may suddenly lose power when using the phone controller as a power source if the **OTG connection** setting on the Android phone is enabled.

To prevent VIVE Flow from suddenly losing power when using the phone controller as a power source, make sure the **OTG connection** setting on the Android phone is disabled. To disable the **OTG connection** setting on Oppo™ or realme™ phones, go to **Settings > Additional settings**, and then disable **OTG connection**.

How do I answer my phone when using VIVE Flow?

If you have Calls in Phone notifications enabled, you'll see a notification in VR when there's an incoming call. See [Managing phone notifications](#) on page 36.



Phone notifications are only available when using Android phones.

When you see an incoming call notification in VIVE Flow, take off VIVE Flow, and then use your phone to answer the call.



You may need to manually disable the phone controller to answer the incoming call. See [About the phone controller](#) on page 11.

How do I report an issue?

If you notice a problem while using VIVE Flow, let us know so we can look into it and make VIVE Flow better.

1. If you're currently running an app, tap/press the **VIVE** button on the controller, and then select **Back to Home**.
2. From Home, select **Settings**.
3. In **General**, select **About > Report issue**.
4. Enter the required information and a description of the issue, and then select **Submit**.

Can I take off VIVE Flow when its updating?

Yes, you can. After taking off VIVE Flow, make sure to cover the proximity sensor with a sticky note or piece of cloth to prevent VIVE Flow from going to sleep mode. The update process will stop if VIVE Flow goes to sleep mode. See [About VIVE Flow](#) on page 6 to know the location of the proximity sensor.

How do I forget VIVE Flow on an iPhone?

After unpairing VIVE Flow from your iPhone, forget VIVE Flow from your phone's Bluetooth list. You need to forget VIVE Flow from your iPhone so you can pair VIVE Flow again.

1. On your phone, go to **Settings** > **Bluetooth**.
2. Under **MY DEVICES**, tap  beside VIVE Flow.
3. Tap **Forget This Device** > **Forget Device**.

System

How do I perform a factory reset on VIVE Flow?

Follow the steps below to perform a factory reset on VIVE Flow from the VIVE app or VIVE Flow app.

1. Plug in VIVE Flow to a power source.
2. On your phone, open the VIVE app or VIVE Flow app.



Make sure your phone and VIVE Flow are connected through Bluetooth.

3. Under Headset, tap your VIVE Flow.
4. Tap **Reset headset** > **Erase all** > **Erase all** > **OK**. This also removes VIVE Flow from the VIVE app or VIVE Flow app.

If you lost your phone or deleted the VIVE app or VIVE Flow app, you can still perform a factory reset on VIVE Flow by using the hardware buttons on VIVE Flow.

1. Plug in VIVE Flow to a power source.
2. Wear VIVE Flow, and wait for the Home screen to appear.
3. Press and hold the Headset, Volume up, and Volume down buttons simultaneously until you see the Reset headset window.



If the volume bar appears or the Reset headset window doesn't show after a while, release the buttons and try again. Make sure to press all three buttons at the same time.

4. Look and hover the cursor on **Erase all data** until the button is selected.
5. Confirm that you want to do a factory reset.

Why can't I see anything in front of me?

Sometimes when you take off VIVE Flow and then wear it again, your orientation is off and the screens in VR are not in front of you anymore. Reset the view to fix your orientation and positions of the screen.

1. On the controller, tap/press the **VIVE** button.
2. Select **More > Reset view**.
3. Follow the onscreen instructions to reset the view.

How do I enjoy VIVE Flow while lying down?

You can still comfortably use VIVE Flow while you're lying down.

On VIVE Flow, go to **Settings > Advanced**, and then turn on **Reposition screens to where your head is facing**. This will make screens in VR appear in front of you even when you're lying down. While lying down, raise your body and head upwards slightly by placing a pillow under your head. This helps improve the VIVE Flow experience compared to lying completely flat.



When using Phone mode, reposition the phone screen by using  on the toolbar. See [Mirroring your phone on VIVE Flow](#) on page 23.

Why can't I reconnect my phone with VIVE Flow?

Try these to reconnect your phone with VIVE Flow:

- Make sure your VIVE Flow is connected to a power source and near your phone.
- If your VIVE Flow is paired with several phones, check if the phone you want to connect to VIVE Flow is listed in the **Switch to another phone** window. See [Switching between paired phones or VR controller](#) on page 30. If your phone is not in the list, pair it again with your VIVE Flow. See [Setting up VIVE Flow using the VIVE app or VIVE Flow app](#) on page 14.
- If you can't see the phone screen while in Phone mode or can't mirror your phone to VIVE Flow, restart your phone and try mirroring your phone again to VIVE Flow. See [Mirroring your phone on VIVE Flow](#) on page 23 for details.

Where do I find the VIVE app accessibility services setting on my Samsung phone?

In the permissions step when setting up VIVE Flow, you may need to manually grant permission for the VIVE app on your phone. Follow the steps below to grant Accessibility Services permission for the VIVE app.

1. In Accessibility Services, tap **Grant**. You'll be taken to the Accessibility page of the phone settings.
2. in Accessibility, tap **Installed services**.
3. Tap **Vive**, and then grant the VIVE app permission.
4. After granting permission, tap < at the top left corner until you get back to the VIVE app.

To learn more about setting up VIVE Flow, go to [Setting up VIVE Flow using the VIVE app or VIVE Flow app](#) on page 14.

Why can't I open Google Assistant in Phone mode?

If Google Assistant™ doesn't open after selecting the Voice assistant button on the toolbar in Phone mode, it may be because Google Assistant didn't close after it was last used.

1. On your phone, swipe down from the top of the screen to disable the phone as controller.
2. Open the recent apps screen.
3. Find Google Assistant, and then swipe up to close it.
4. Open the notifications panel, and then enable the phone as controller. See [About the phone controller](#) on page 11.
5. Try opening Google Assistant again by selecting the Voice assistant button on the toolbar in Phone mode.

What should I do if Phone mode crashes or doesn't work on my Xiaomi phone?

It may be because your phone doesn't allow the VIVE app to run in the background. Follow the steps below to grant the VIVE app permission to run in the background.

1. On your phone, go to Settings.
2. Under Apps, tap **Manage apps > VIVE**.
3. Under Permissions, tap **Other permissions**.
4. Under Settings, enable **Start in background**.

What should I do if I can't grant permission for Accessibility Services ?

Accessibility Services is needed in order to use your phone as a controller for VIVE Flow. If the **Grant** button in the permissions step when you're setting up VIVE Flow doesn't become  even if you've already granted permission, do this:

1. On your phone, go to Settings.
2. Search for `accessibility` and then tap it.



If multiple hits are found, tap the one that goes to the Accessibility page in the phone settings.

3. Tap **Vive**.
4. Tap the Use service **On/Off** switch to turn off, and then tap it again to turn it on.
5. Tap the back button until you get back to the VIVE app and check if permission is granted for Accessibility Service.

To learn more about setting up VIVE Flow, go to [Setting up VIVE Flow using the VIVE app or VIVE Flow app](#) on page 14.

How do I update VIVE Flow to support iPhone?

If you don't have an Android phone or VR controller, follow the steps below to update the VIVE Flow software to support using an iPhone as a controller.

- Windows computer**
1. On your computer, download the [installation package](#).
 2. Unzip the files to a folder on your computer.
 3. Double-click **USBDriver.exe** to install the driver.
 4. If VIVE Flow is connected to a power source, unplug it.
 5. While holding down the Volume Down button on VIVE Flow, connect VIVE Flow to your computer using a USB Type-C cable. You'll see the Download mode screen in VIVE Flow.

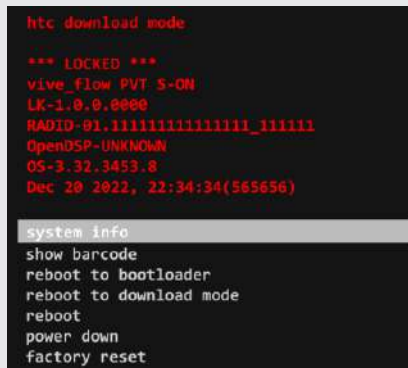

```

htc download mode

*** LOCKED ***
vive_flow PVT S-ON
LK-1.0.0.0000
RADIO-01.1111111111111111_111111
OpenDSP-UNKNOWN
OS-3.32.3453.8
Dec 20 2022, 22:34:34(565656)

system info
show barcode
reboot to bootloader
reboot to download mode
reboot
power down
factory reset
  
```

6. On your computer, go to the folder where you unzipped the files. Double-click **VIVEFLOW.bat** to install the software update. Wait for the update to finish.
7. Press any key on your computer. VIVE Flow will restart and you can set it up. See [Setting up VIVE Flow using the VIVE app or VIVE Flow app](#) on page 14.

- macOS computer**
1. On your computer, download the [installation package](#).
 2. Unzip the files to a folder on your computer.
 3. If VIVE Flow is connected to a power source, unplug it.
 4. While holding down the Volume Down button on VIVE Flow, connect VIVE Flow to your computer using a USB Type-C cable. You'll see the Download mode screen in VIVE Flow.

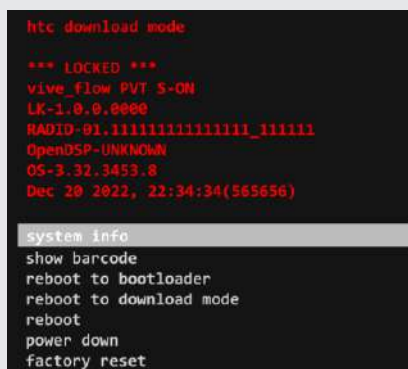

```

htc download mode

*** LOCKED ***
vive_flow PVT S-ON
LK-1.0.0.0000
RADIO-01.1111111111111111_111111
OpenDSP-UNKNOWN
OS-3.32.3453.8
Dec 20 2022, 22:34:34(565656)

system info
show barcode
reboot to bootloader
reboot to download mode
reboot
power down
factory reset
  
```

5. On your computer, open the **Terminal** app.

6. On the **Terminal** window, type `sh` and a space, and then drag **VIVEFlow.sh** from the folder where you unzipped the files to the **Terminal** window to install the update. Wait for the update to finish.
7. Press any key on your computer. VIVE Flow will restart and you can set it up. See [Setting up VIVE Flow using the VIVE app or VIVE Flow app](#) on page 14.



Updating the VIVE Flow software may take some time to finish. Please be patient.

Hardware

What does the Headset button do?

On the top-right side of the VR glasses, the Headset button allows you to control several basic functions.

Function	Headset button
Activate or deactivate passthrough (See your real surroundings in VR)	Double-click
Select an item in Gaze mode.	Single click while looking at a menu item. When the phone controller is not found, you can look at menus and then press to select.
Open a menu where you can restart the VR glasses and enable/disable Passenger mode.	Press and hold for 2 seconds.
Force restart the VR glasses if it's unresponsive.	Press and hold for 12 seconds.

What does the status light on VIVE Flow mean?

The LED shows:

- Flashing white when VIVE Flow is booting up.
- Breathing white when VIVE Flow is on standby.
- Flashing orange when passthrough is turned on.
- Solid orange when the device temperature is higher than normal or performance is reduced. If this occurs, turn off your device and wait 30 minutes before turning it on again.

What can I do if the phone controller doesn't work?

Once paired, your phone should be automatically detected when connected to VIVE Flow.

- Make sure you are using the phone you paired with your VIVE Flow.
- Make sure Bluetooth on your phone is turned on and is connected to your VIVE Flow.
- Phone controller might be disabled on your phone. See [About the phone controller](#) on page 11.
- Make sure your phone has power.

Why can't I enable the phone controller from my phone?

If you can't enable the phone controller, check the following:

Android phones	<p>If you disabled the phone controller from your phone's Notifications panel, you won't be able to enable the phone controller again if notifications for the VIVE app are turned off.</p> <p>Go to your phone settings and make sure that Allow Notifications or Show Notifications is turned on for the VIVE app.</p>
iPhone	<p>Make sure the VIVE Flow app is the active app—the app onscreen—on your phone.</p> <p>If the VIVE Flow app is not the active app, tap it in the App Switcher.</p>

What can I do if the phone controller is not responsive or lags?

If you're using an HTC U11 or HTC U11+ as your phone controller for VIVE Flow, turn off the **Location** setting on the phone. In Settings, tap **Location**, and then turn off the Use location **On/Off** switch.

What should I do when the phone controller disappears or doesn't work in VR?

If the phone controller suddenly disappears, it may be for one of the following reasons:

- VIVE Flow got disconnected from your phone. Make sure the VR glasses and your phone are connected via Bluetooth.
- The VIVE app closed unexpectedly. Some phones automatically close apps when they detect that the app is running in the background. To resolve this, you'll need to change your phone's power management settings so the VIVE app can run uninterrupted in the background. The table below shows where the applicable power management setting is on some common phones. If you have trouble finding it, consult your phone's user guide.

Phone manufacturer	Power management setting path
ASUS	<ol style="list-style-type: none"> 1. Go to Settings > Apps & notifications > See all XX apps > VIVE > Battery > Battery optimization. 2. Select All apps from the drop-down, and then find and tap VIVE. 3. Select Don't optimize, and then tap Done.
Huawei	<ol style="list-style-type: none"> 1. Go to Settings > Battery > App launch. 2. Turn off the VIVE On/Off switch.
OnePlus	<ol style="list-style-type: none"> 1. Go to Settings > Battery > Battery optimization. 2. Tap VIVE, and then tap Don't optimize.
Oppo or Realme	<ol style="list-style-type: none"> 1. Go to Settings > Battery > App battery management > VIVE and enable Allow background activity and Allow auto launch. <p>If you're using an Oppo Find X3 Pro, enable Allow this app to launch other apps or services.</p>

Phone manufacturer	Power management setting path
	<ol style="list-style-type: none"> Go to Settings > Battery > More battery settings > Optimize battery use > VIVE and enable Don't optimize.
Samsung	<ol style="list-style-type: none"> Go to Settings > Apps > VIVE > Battery. Tap Optimize battery usage > Apps not optimized > All. Search for VIVE, and then turn off the On/Off switch.
Vivo	<ol style="list-style-type: none"> Go to Settings > Battery > Background power consumption management. Tap VIVE > Don't restrict background power usage.
Xiaomi	<ol style="list-style-type: none"> Go to Settings > Battery & performance > Settings icon (upper-right corner) > App battery saver. Tap VIVE > No restrictions.

What do I do if my VIVE Flow isn't responding?

If your VIVE Flow is plugged in to a power source but isn't responding or needs to be restarted, you can manually restart it.



Manual restarts will cause all unsaved data to be lost.

Press and hold the Headset button for 12 seconds to perform a hardware restart.

If your VR glasses still won't respond, contact customer support.

What phones can I use with VIVE Flow?

Check the table below to see which phones you can use with VIVE Flow.

Android phones	Most Android phones can be used with VIVE Flow but we strongly recommend using a phone that supports Miracast and HDCP 2.2 and above. Having these features on the phone let you enjoy the full VIVE Flow experience. For a list of recommended Android phones, go to https://www.vive.com/vive-flow-phone-list/ .
iPhone	iPhone 8 or newer with iOS version 14.4.2 or later.

Why can't VIVE Flow connect to my iPhone?

The VIVE Flow software may not be updated to the version that supports connecting to iPhone. Check the following:

If VIVE Flow is new	Connect VIVE Flow to a power source, and then put it on. Check if you see the App Store badge in the setup screen.  If you don't see the App Store badge, update VIVE Flow to the latest software version. See How do I update VIVE Flow to support iPhone? on page 43.
If VIVE Flow is in use	Check if the VIVE Flow system version is 2.xxx.x.x or later. To check, put on VIVE Flow, and then go to Settings > General > System update . If the System version is not 2.xxx.x.x or later, update VIVE Flow to the latest software version. See How do I update VIVE Flow to support iPhone? on page 43.

Why do I see a pairing request on my iPhone?

Whenever VIVE Flow is restarted or you switch to your iPhone to use it as a controller, you'll see the **Bluetooth Pairing Request** dialog box. Tap **Pair** so you can use your iPhone as a controller.

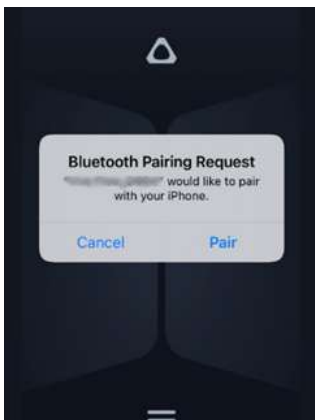

Apps and content

Why don't I see any gifted apps in my VIVE Flow?

If you've redeemed your promo code for your special offer but you don't see any of your gifted apps in the VIVE Flow **Library**, check the following:

- Make sure your VIVE Flow is up to date. You can check for system updates in **Settings > General**.
- Make sure your VIVE Flow is connected to Wi-Fi. Go to **Settings > Connectivity** to check your network settings
- Make sure you're logged in to VIVE Flow with the right account. You can check which account you're logged in with by selecting **Profile** from the lobby.

After you redeem your promo code, your gifted apps will be delivered directly to your VIVE Flow when you log in. However, after you redeem your promo code, it may take some time for the apps to appear in the **Library**. If you don't see any apps after redeeming your code, check the **Library** again after 24 hours. If you still don't see any of your gifted apps after 24 hours, contact HTC support for assistance.

Why don't I see the "Special offers" popup when setting up VIVE Flow?

If you don't see the "Special offers" popup when setting up your VIVE Flow, make sure you haven't previously logged in to the VIVE app to set up your VIVE Flow.

The "Special offers" popup only appears in the VIVE app the first time you set up your VIVE Flow. If you've previously logged in to the VIVE app to set up or use a different VIVE Flow, you won't see the Special offers screen.

If you see the "Special offers" popup while setting up your VIVE Flow, your promo code has automatically been applied to your HTC account. You can visit <http://www.viveport.com/myredeem> to redeem your offer.

If you see the "Special offers" popup during setup, but your promo code doesn't automatically appear on <http://www.viveport.com/myredeem>, contact HTC support for assistance.

Why does casting stop when I enter Kiosk mode?

If casting stops when you enter Kiosk mode, check your Kiosk mode's network permission setting.

1. Press and hold the headset button until a menu appears, and then select **Quit Kiosk mode**. Enter your passcode if you have one.
2. From Home, select **Settings**.
3. Select **Kiosk Mode**.
4. In **Network permission**, select either **Any network** or **Preset network only**.



If **Offline only** is selected, screen casting will stop when you enter Kiosk mode. You have to manually start casting again.

My phone supports phone mirroring, why doesn't Phone mode work?

It may be because VIVE Flow cannot automatically connect to your phone. Follow the steps below to start mirroring your phone on VIVE Flow.

1. Take off VIVE Flow.
2. On your phone, go to Settings.
3. Search for Miracast.



Different phones have different names for Miracast (e.g. Cast or Smart View) or Miracast may not be in the phone settings. See [Where do I find the Miracast setting on my phone?](#) on page 49.

4. Tap **Vive_Flow_[Last 4 digits of Bluetooth address]**.
5. Wear VIVE Flow again.

To learn more about Phone mirroring, go to [Mirroring your phone on VIVE Flow](#) on page 23.

Where do I find the Miracast setting on my phone?

The table below shows where the Miracast setting is on some common phones. If you have trouble finding the Miracast setting on your phone, consult your phone's user guide.

Phone manufacturer	Miracast path
HTC	Go to Settings > Connected devices > Connection preferences > Cast .
Huawei	Go to Settings > Device connectivity > Wireless projection .
Huawei™ Mate 40	Go to Settings > More connections > Easy Projection > Wireless Projection .
LG	Go to Settings > Connected devices > Screen sharing .
realme	Go to Settings > Connection & sharing > Screencast .
Samsung	<ol style="list-style-type: none"> 1. Swipe down from the top of the screen to open the Notifications panel. 2. Tap Media > Smart View.
Sony	Go to Settings > Device connection > Connection preferences > Screen mirroring .
Xiaomi	Go to Settings > Connection & sharing > Wireless display > Wireless display .

Why can't Miracast be detected on my HTC, Samsung, or Oppo phone?

If your phone supports Miracast, you need to allow the VIVE app to access it. When setting up VIVE Flow, there is a step where the VIVE app checks if your phone supports Miracast. When it gets to this step, check for a message that pops up asking if you want to allow the VIVE app to access Miracast. Make sure to tap **Allow** on the message.

To learn more about setting up VIVE Flow, go to [Setting up VIVE Flow using the VIVE app or VIVE Flow app](#) on page 14.

Where can I find my screenshots and screen recordings?

Screenshots and screen recordings are saved in the internal storage. Go to the **File browser** in the Storage settings to find them.

1. From Home, select **Settings**.
2. Select **Storage > File browser**.
3. Open the Captures folder.
4. Select the thumbnail of a screenshot or screen recording to see a larger view.

What should I do if I can't play back my video from my Android phone?

It may be because the content you're trying to play back has DRM-protection. Your phone needs to support HDCP 2.2 or later to be able to play back DRM-protected content on VIVE Flow. Check your phone manufacturer's website to see if your phone supports HDCP 2.2. To check a list of recommended phones to use with VIVE Flow, go to <https://www.vive.com/vive-flow-phone-list/>.

Why can't I watch 360-degree YouTube videos in Phone mode?

When in Phone mode, VIVE Flow only mirrors what's shown on your phone screen. Use phone mode to watch standard videos and movies on your own personal big screen.

To watch 360-degree YouTube® videos, use VIVE Browser in the VIVE Flow Library to go to the YouTube website. You can then search for 360-degree videos to watch.

If you have 360-degree videos you want to watch in VIVE Flow, you can use **VIVEPORT Video**. See [Playing videos from local storage](#) on page 28.

What should I do if I can't play back content from my OnePlus phone in Phone mode?

If you're using the OnePlus 8T, just restart your phone, and then try playing back the content again.

Trademarks and copyrights

©2023 HTC Corporation. All Rights Reserved.

VIVE, the VIVE logo, HTC, the HTC logo, VIVEPORT, and all other HTC product and service names are trademarks and/or registered trademarks of HTC Corporation and its affiliates in the U.S. and other countries.

All other trademarks and service marks mentioned herein, including company names, product names, service names and logos, are the property of their respective owners and their use herein does not indicate an affiliation with, association with, or endorsement of or by HTC Corporation. Not all marks listed necessarily appear in this User Guide.

Screen images contained herein are simulated. HTC shall not be liable for technical or editorial errors or omissions contained herein, nor for incidental or consequential damages resulting from furnishing this material. The information is provided “as is” without warranty of any kind and is subject to change without notice. HTC also reserves the right to revise the content of this document at any time without prior notice.

No part of this document may be reproduced or transmitted in any form or by any means, electronic or mechanical, including photocopying, recording or storing in a retrieval system, or translated into any language in any form without prior written permission of HTC.

Index

Symbols

360 videos *50*

A

Adjusting diopter dial *9*

Adjusting face cushion/face gasket *9*

B

blue light filter *20*

C

Capturing screenshots and screen recordings *25*

Caring for your VIVE Flow *33*

Casting screen to another device *29*

Changing boundary size *20*

Cleaning your VIVE Flow *33*

Connecting to a power source *8*

Connecting to Wi-Fi network *19*

Copying files from computer to VIVE Flow *26*

Copying screenshots and recordings to computer *25*

D

Downloading free titles *17*

F

Factory reset *40*

First time setup *14*

H

Hardware

- about VIVE Flow *6*

- diopter dial *9*

- Inside the box *6*

- phone as controller *11*

HTC Account *16*

I

Inside the box *6*

M

Mirror your phone on VIVE Flow *23*

P

Pairing Bluetooth devices *31*

Passenger mode *22*

Passthrough *29*

Phone as controller *11*

Phone mirroring *23*

Phone mode *23*

Purchasing VR titles *17*

S

Screen capture *25*

Screen casting *29*

Screen recording *25*

Seeing your real surroundings *29*

Setting up VIVE Flow *14*

Settings

- boundary size *20*

- Eye comfort mode *20*

- passenger mode *22*

- preferred way to hold phone *20*

Supported phones *47*

T

Turning on Eye comfort mode *20*

U

Uninstalling apps *32*

Updating firmware *33*

V

VIVE app

- about *35*

- installing updates *36*
- languages *36*
- phone notifications *36*
- supported phones *35*
- uninstalling *36*

VIVEPORT *17*

VR titles

- Free *17*
- Purchasing *17*

W

Wearing VIVE Flow *9*

Wi-Fi *19*